

MECHANICAL CASE OUTLINE

PACKAGE DIMENSIONS

ON Semiconductor®

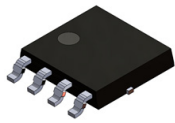

LFPAK8 5x6 CASE 760AA ISSUE C

DATE 13 AUG 2019

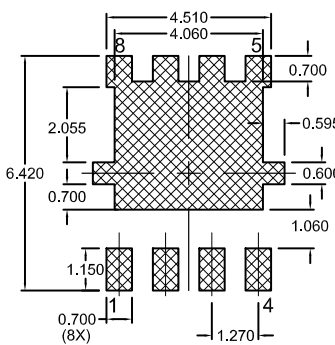
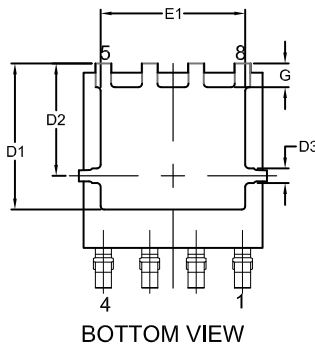
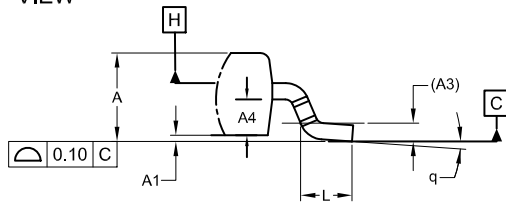
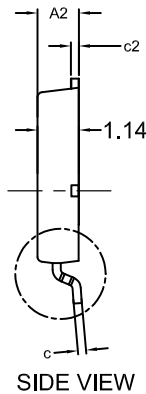
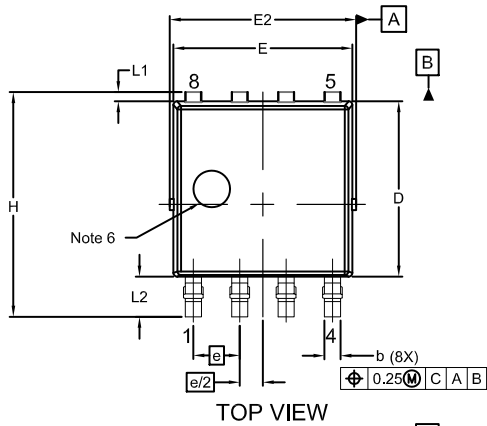

NOTES:

1. DIMENSIONING AND TOLERANCING PER ASME Y14.5M, 1994.
2. CONTROLLING DIMENSION: MILLIMETERS.
3. DIMENSIONS D AND E DO NOT INCLUDE MOLD FLASH, PROTRUSIONS, OR BURRS. MOLD FLASH PROTRUSIONS OR GATE BURRS SHALL NOT EXCEED 0.150mm PER SIDE.
4. DIMENSIONS D AND E ARE DETERMINED AT THE OUTERMOST EXTREMES OF THE PLASTIC BODY.
5. DATUMS A AND B ARE DETERMINED AT DATUM PLANE H.
6. OPTIONAL MOLD FEATURE.

MILLIMETERS			
DIM	MIN	NOM	MAX
A	1.10	1.20	1.30
A1	0.00	0.08	0.15
A2	1.10	1.15	1.20
A3	0.25 REF		
A4	0.45	0.50	0.55
b	0.40	0.45	0.50
c	0.19	0.22	0.25
c2	0.19	0.22	0.25
D	4.70	4.80	4.90
D1	3.80	4.00	4.20
D2	3.00	3.10	3.20
D3	0.30	0.40	0.50
E	4.80	4.90	5.00
E1	3.90	4.00	4.10
E2	5.00	5.15	5.30
e	1.27 BSC		
G	0.55	0.65	0.75
H	6.00	6.15	6.30
L	0.45	0.65	0.85
L1	0.15	0.25	0.35
L2	0.90	1.10	1.30
q	0°	4°	8°

RECOMMENDED LAND PAD

*FOR ADDITIONAL INFORMATION ON OUR PB-FREE STRATEGY AND SOLDERING DETAILS, PLEASE DOWNLOAD THE ON SEMICONDUCTOR SOLDERING AND MOUNTING TECHNIQUES REFERENCE MANUAL, SOLDERRM/D.

GENERIC MARKING DIAGRAM*

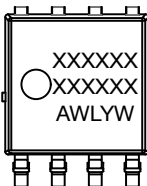

- XXXXXX = Specific Device Code
- A = Assembly Location
- WL = Wafer Lot
- Y = Year
- W = Work Week

*This information is generic. Please refer to device data sheet for actual part marking. Some products may not follow the Generic Marking.

DOCUMENT NUMBER:	98AON82475G	Electronic versions are uncontrolled except when accessed directly from the Document Repository. Printed versions are uncontrolled except when stamped "CONTROLLED COPY" in red.
DESCRIPTION:	LFPAK8 5x6	PAGE 1 OF 1

ON Semiconductor and ON are trademarks of Semiconductor Components Industries, LLC dba ON Semiconductor or its subsidiaries in the United States and/or other countries. ON Semiconductor reserves the right to make changes without further notice to any products herein. ON Semiconductor makes no warranty, representation or guarantee regarding the suitability of its products for any particular purpose, nor does ON Semiconductor assume any liability arising out of the application or use of any product or circuit, and specifically disclaims any and all liability, including without limitation special, consequential or incidental damages. ON Semiconductor does not convey any license under its patent rights nor the rights of others.