

IGBT – Power, Co-PAK N-Channel, Field Stop VII (FS7), SCR, TO247-3L 1200 V, 1.5 V, 40 A

FGHL40T120RWD

Description

Using the novel field stop 7th generation IGBT technology and the Gen7 Diode in TO247 3-lead package, FGHL40T120RWD offers the optimum performance with low conduction losses and good switching controllability for a high efficiency operation in various applications like motor control, UPS, data center and high-power switch.

Features

- Low Conduction Loss and Optimized Switching
- Maximum Junction Temperature – $T_J = 175^\circ\text{C}$
- Positive Temperature Coefficient for Easy Parallel Operation
- High Current Capability
- 100% of the Parts are Dynamically Tested
- Short Circuit Rated
- RoHS Compliant

Applications

- Motor Control
- UPS
- General Application Requiring High Power Switch

MAXIMUM RATINGS ($T_J = 25^\circ\text{C}$ unless otherwise noted)

Parameter	Symbol	Value	Unit
Collector-to-Emitter Voltage	V_{CES}	1200	V
Gate-to-Emitter Voltage	V_{GES}	± 20	
Transient Gate-to-Emitter Voltage		± 30	
Collector Current	I_C	$T_C = 25^\circ\text{C}$ (Note 1)	80
		$T_C = 100^\circ\text{C}$	40
Power Dissipation	P_D	$T_C = 25^\circ\text{C}$	600
		$T_C = 100^\circ\text{C}$	300
Pulsed Collector Current	I_{CM}	120	A
Diode Forward Current	I_F	$T_C = 25^\circ\text{C}$ (Note 1)	80
		$T_C = 100^\circ\text{C}$	40
Pulsed Diode Maximum Forward Current	I_{FM}	120	
Short Circuit Withstand Time $V_{GE} = 15\text{ V}$, $V_{CC} = 600\text{ V}$, $T_C = 150^\circ\text{C}$	T_{SC}	5	μs
Operating Junction and Storage Temperature Range	T_J, T_{stg}	-55 to +175	$^\circ\text{C}$
Lead Temperature for Soldering Purposes	T_L	260	

Stresses exceeding those listed in the Maximum Ratings table may damage the device. If any of these limits are exceeded, device functionality should not be assumed, damage may occur and reliability may be affected.

1. Value limit by bond wire.
2. Repetitive rating: pulse width limited by max. Junction temperature.

BV_{CES}	$V_{CE(SAT)}$	I_C
1200 V	1.5 V	40 A

PIN CONNECTIONS

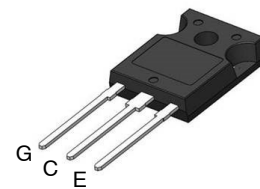
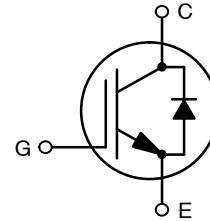

TO-247-3LD
CASE 340CX

MARKING DIAGRAM

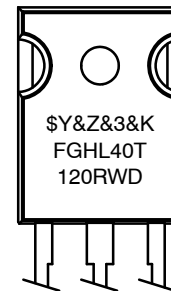

\$Y = onsemi Logo
&Z = Assembly Plant Code
&3 = 3-Digit Date Code
&K = 2-Digit Lot Traceability Code
FGHL40T120RWD = Specific Device Code

ORDERING INFORMATION

Device	Package	Shipping
FGHL40T120RWD	TO-247 (Pb-Free)	30 Units / Tube

FGHL40T120RWD

THERMAL CHARACTERISTICS

Parameter	Symbol	Value	Unit
Thermal Resistance, Junction-to-Case for IGBT	$R_{\theta JC}$	0.25	°C/W
Thermal Resistance, Junction-to-Case for Diode	$R_{\theta JCD}$	0.42	
Thermal Resistance, Junction-to-Ambient	$R_{\theta JA}$	40	

ELECTRICAL CHARACTERISTICS OF IGBT ($T_J = 25^\circ\text{C}$ unless otherwise noted)

Parameter	Symbol	Test Conditions	Min	Typ	Max	Unit
OFF CHARACTERISTICS						
Collector-to-Emitter Breakdown Voltage	BV_{CES}	$V_{GE} = 0\text{ V}, I_C = 5\text{ mA}$	1200			V
Collector-to-Emitter Breakdown Voltage Temperature Coefficient	$\frac{\Delta BV_{CES}}{\Delta T_J}$			1226		
Zero Gate Voltage Collector Current	I_{CES}	$V_{GE} = 0\text{ V}, V_{CE} = V_{CES}$			40	μA
Gate-to-Emitter Leakage Current	I_{GES}	$V_{GE} = 20\text{ V}, V_{CE} = 0\text{ V}$			±400	nA

ON CHARACTERISTICS

Gate Threshold Voltage	$V_{GE(th)}$	$V_{GE} = V_{CE}, I_C = 40\text{ mA}, T_J = 25^\circ\text{C}$	4.9	5.94	6.7	V
Collector-to-Emitter Saturation Voltage	$V_{CE(sat)}$	$V_{GE} = 15\text{ V}, I_C = 40\text{ A}, T_J = 25^\circ\text{C}$	1.2	1.49	1.8	
		$V_{GE} = 15\text{ V}, I_C = 40\text{ A}, T_J = 175^\circ\text{C}$		1.83		

DYNAMIC CHARACTERISTICS

Input Capacitance	C_{ies}	$V_{GE} = 0\text{ V}, V_{CE} = 30\text{ V}, f = 1\text{ MHz}$		4670		pF
Output Capacitance	C_{oes}			171		
Reverse Transfer Capacitance	C_{res}			16.7		
Total Gate Charge	Q_g	$V_{CE} = 600\text{ V}, V_{GE} = 15\text{ V}, I_C = 40\text{ A}$		174		nC
Gate-to-Emitter Charge	Q_{ge}			42.2		
Gate-to-Collector Charge	Q_{gc}			73		

SWITCHING CHARACTERISTICS

Turn-on Delay Time	$t_{d(on)}$	$V_{CE} = 600\text{ V}, V_{GE} = 0/15\text{ V}, I_C = 20\text{ A}, R_G = 4.7\ \Omega, T_J = 25^\circ\text{C}$		37		ns
Turn-off Delay Time	$t_{d(off)}$			269		
Rise Time	t_r			22		
Fall Time	t_f			136		
Turn-on Switching Loss	E_{on}			1.2		mJ
Turn-off Switching Loss	E_{off}			1.4		
Total Switching Loss	E_{ts}			2.6		
Turn-on Delay Time	$t_{d(on)}$	$V_{CE} = 600\text{ V}, V_{GE} = 0/15\text{ V}, I_C = 40\text{ A}, R_G = 4.7\ \Omega, T_J = 25^\circ\text{C}$		38		ns
Turn-off Delay Time	$t_{d(off)}$			184		
Rise Time	t_r			46		
Fall Time	t_f			134		
Turn-on Switching Loss	E_{on}			2.9		mJ
Turn-off Switching Loss	E_{off}			2.1		
Total Switching Loss	E_{ts}			5.0		

FGHL40T120RWD

ELECTRICAL CHARACTERISTICS OF IGBT ($T_J = 25^\circ\text{C}$ unless otherwise noted) (continued)

Parameter	Symbol	Test Conditions	Min	Typ	Max	Unit
SWITCHING CHARACTERISTICS						
Turn-on Delay Time	$t_{d(on)}$	$V_{GE} = 0/15\text{ V}, I_C = 20\text{ A},$ $V_{CE} = 600\text{ V}, R_G = 4.7\ \Omega,$ $T_J = 175^\circ\text{C}$		34		ns
Turn-off Delay Time	$t_{d(off)}$			328		
Rise Time	t_r			24		
Fall Time	t_f			240		
Turn-on Switching Loss	E_{on}			2.2		mJ
Turn-off Switching Loss	E_{off}			2.2		
Total Switching Loss	E_{ts}			4.4		
Turn-on Delay Time	$t_{d(on)}$	$V_{GE} = 0/15\text{ V}, I_C = 20\text{ A},$ $V_{CE} = 600\text{ V}, R_G = 4.7\ \Omega,$ $T_J = 175^\circ\text{C}$		38		ns
Turn-off Delay Time	$t_{d(off)}$			213		
Rise Time	t_r			51		
Fall Time	t_f			205		
Turn-on Switching Loss	E_{on}			4.5		mJ
Turn-off Switching Loss	E_{off}			2.9		
Total Switching Loss	E_{ts}			7.4		

DIODE CHARACTERISTICS

Forward Voltage	V_F	$I_F = 40\text{ A}, T_J = 25^\circ\text{C}$	1.46	1.69	2.08	V
		$I_F = 40\text{ A}, T_J = 175^\circ\text{C}$		1.63		

DIODE SWITCHING CHARACTERISTICS, INDUCTIVE LOAD

Reverse Recovery Time	t_{rr}	$V_R = 600\text{ V}, I_F = 20\text{ A},$ $di_F/dt = 500\text{ A}/\mu\text{s}, T_J = 25^\circ\text{C}$		163		ns
Reverse Recovery Charge	Q_{rr}			1462		nC
Reverse Recovery Energy	E_{REC}			0.5		mJ
Peak Reverse Recovery Current	I_{RRM}			17.9		A
Reverse Recovery Time	t_{rr}	$V_R = 600\text{ V}, I_F = 40\text{ A},$ $di_F/dt = 500\text{ A}/\mu\text{s}, T_J = 25^\circ\text{C}$		248		ns
Reverse Recovery Charge	Q_{rr}			2372		nC
Reverse Recovery Energy	E_{REC}			0.8		mJ
Peak Reverse Recovery Current	I_{RRM}			19.2		A
Reverse Recovery Time	t_{rr}	$V_R = 600\text{ V}, I_F = 20\text{ A},$ $di_F/dt = 500\text{ A}/\mu\text{s}, T_J = 175^\circ\text{C}$		269		ns
Reverse Recovery Charge	Q_{rr}			3447		nC
Reverse Recovery Energy	E_{REC}			1.3		mJ
Peak Reverse Recovery Current	I_{RRM}			25.6		A
Reverse Recovery Time	t_{rr}	$V_R = 600\text{ V}, I_F = 40\text{ A},$ $di_F/dt = 500\text{ A}/\mu\text{s}, T_J = 175^\circ\text{C}$		422		ns
Reverse Recovery Charge	Q_{rr}			5717		nC
Reverse Recovery Energy	E_{REC}			2.3		mJ
Peak Reverse Recovery Current	I_{RRM}			27.1		A

Product parametric performance is indicated in the Electrical Characteristics for the listed test conditions, unless otherwise noted. Product performance may not be indicated by the Electrical Characteristics if operated under different conditions.

FGHL40T120RWD

TYPICAL CHARACTERISTICS

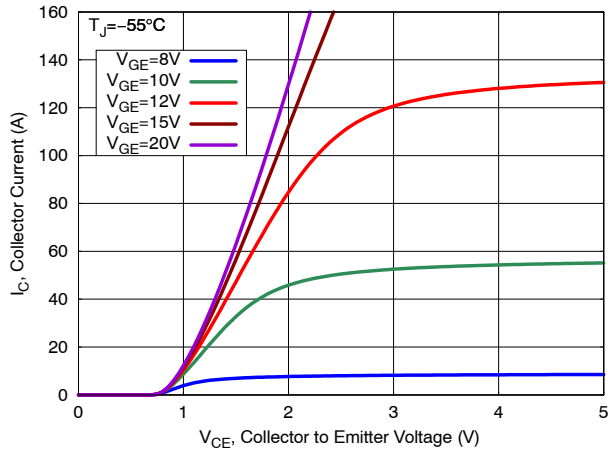

Figure 1. Output Characteristics

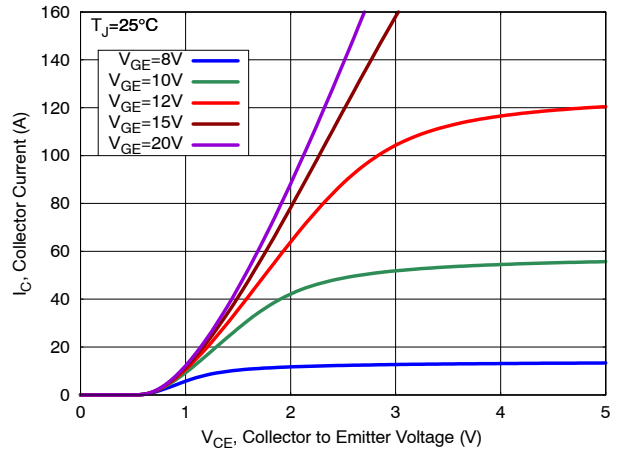

Figure 2. Output Characteristics

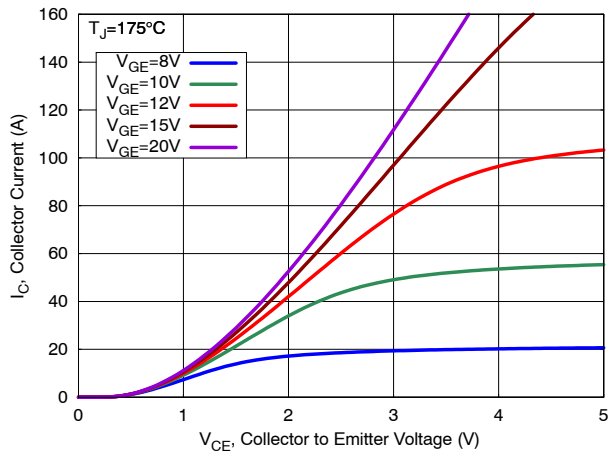

Figure 3. Output Characteristics

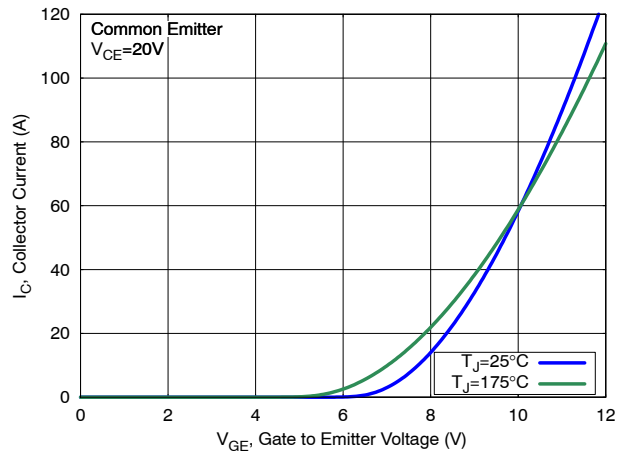

Figure 4. Transfer Characteristics

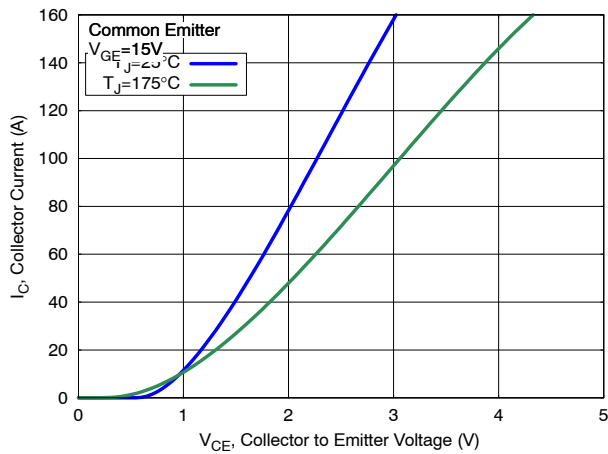

Figure 5. Saturation Characteristics

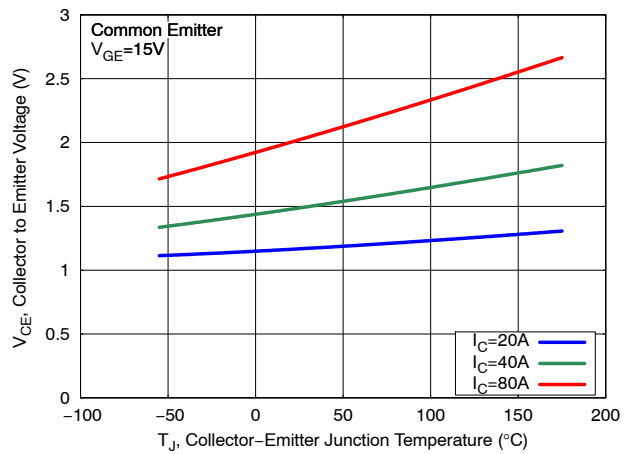

Figure 6. Saturation Voltage vs. Junction Temperature

FGHL40T120RWD

TYPICAL CHARACTERISTICS

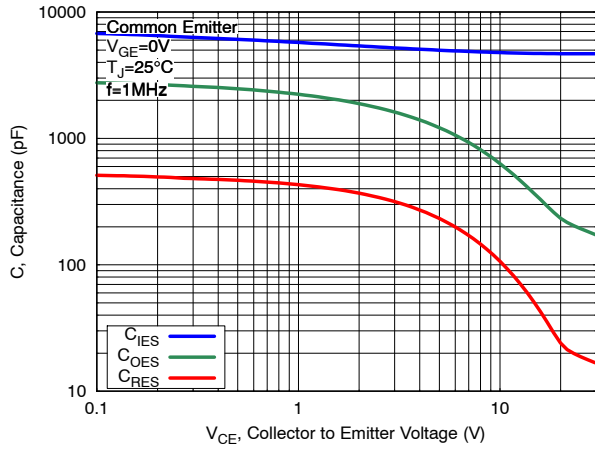

Figure 7. Capacitance Characteristics

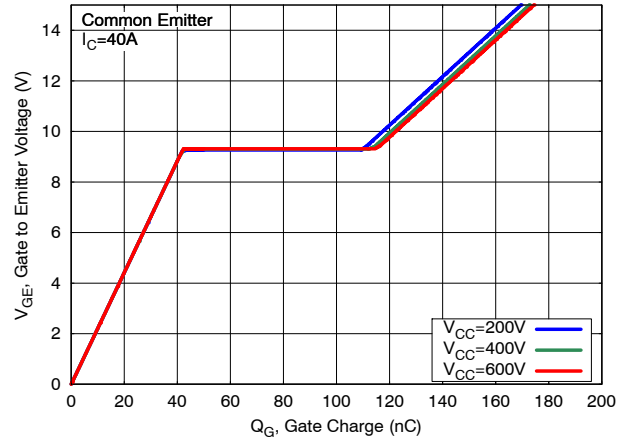

Figure 8. Gate Charge Characteristics

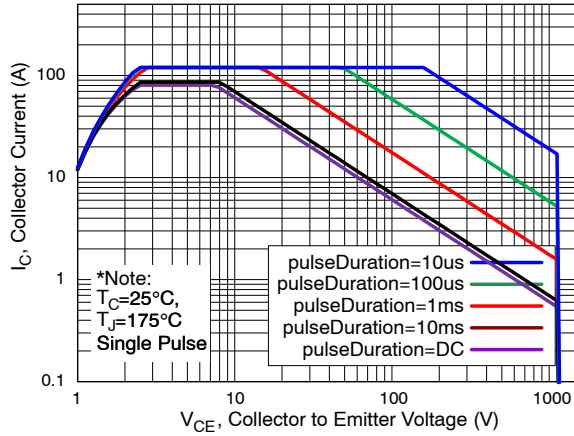

Figure 9. SOA Characteristics

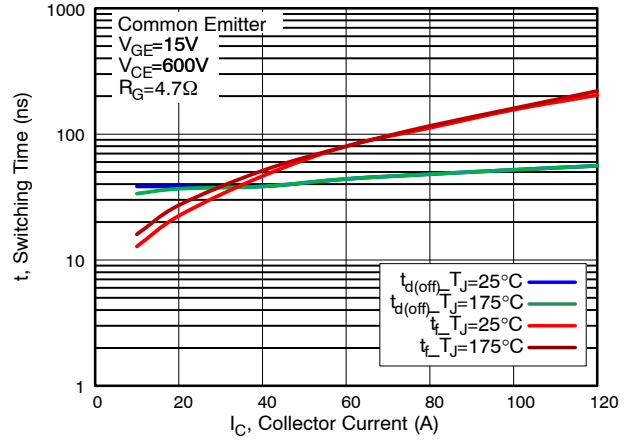

Figure 10. Turn-On Switching Time vs Collector Current

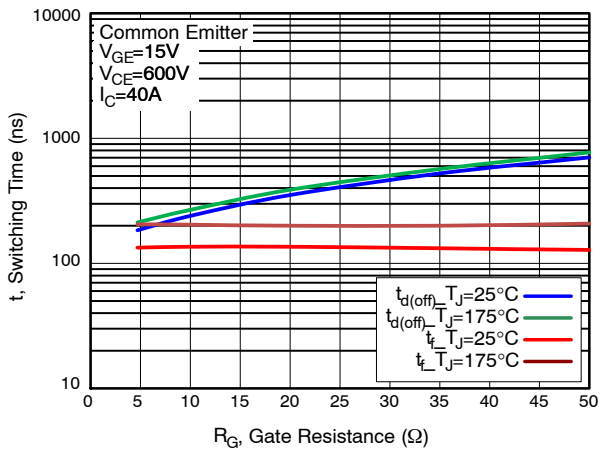

Figure 11. Turn-Off Switching Time vs. Gate Resistance

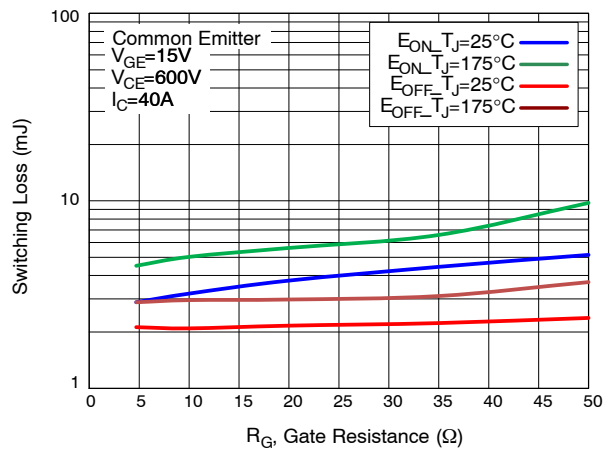

Figure 12. Switching Loss vs. Gate Resistance

FGHL40T120RWD

TYPICAL CHARACTERISTICS

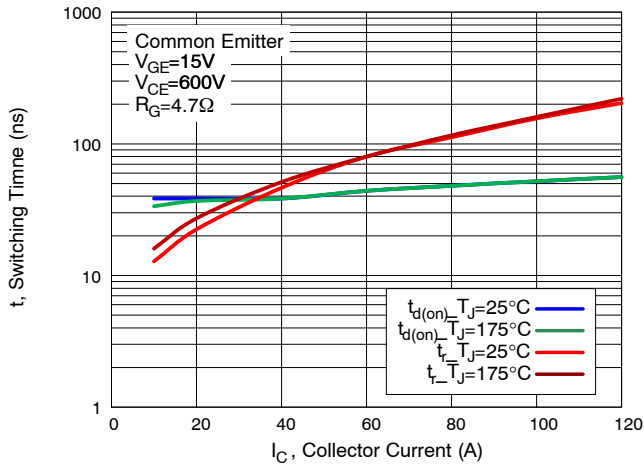

Figure 13. Turn-On Switching Time vs. Collector Current

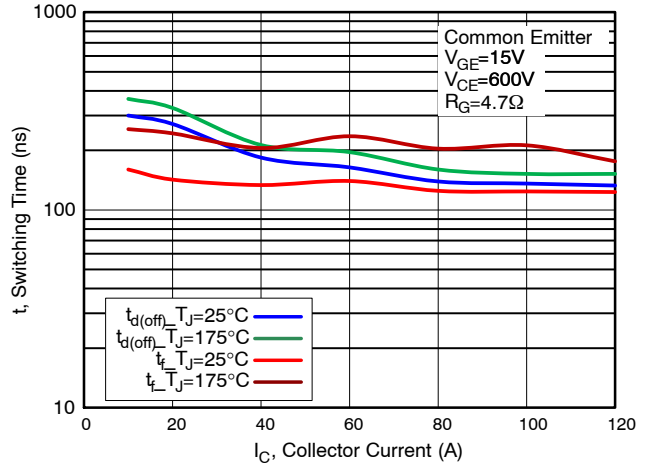

Figure 14. Turn-Off Switching Time vs. Collector Current

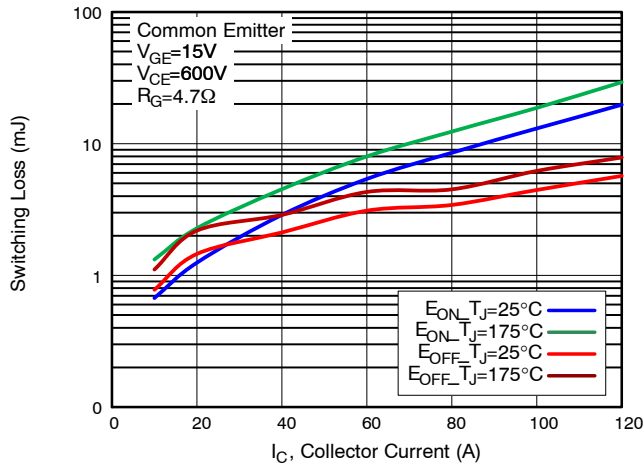

Figure 15. Switching Loss vs. Collector Current

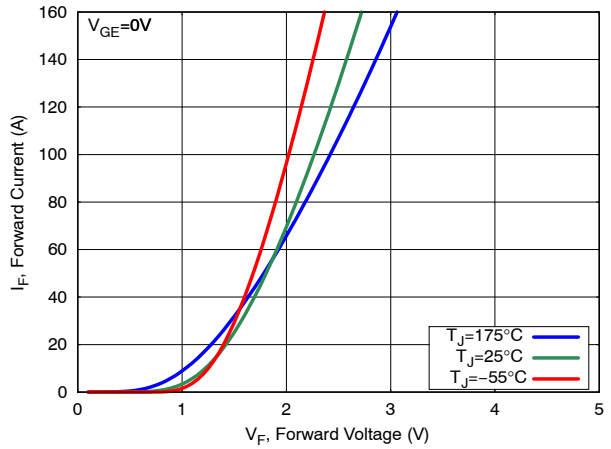

Figure 16. Diode Forward Characteristics

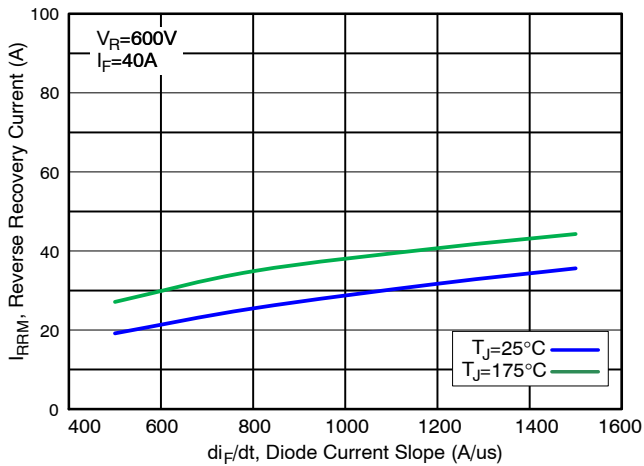

Figure 17. Diode Reverse Recovery Current

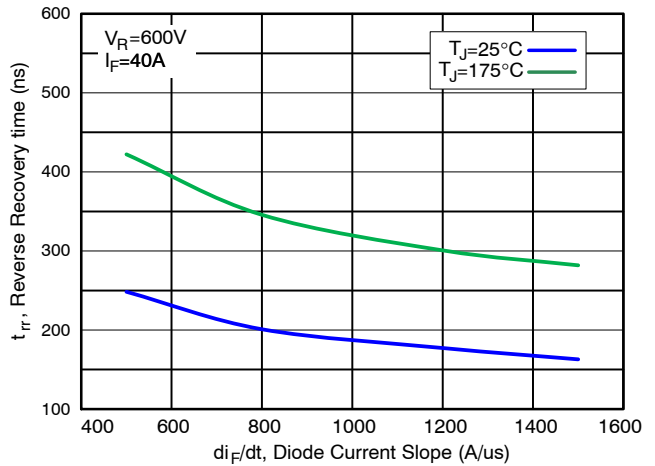

Figure 18. Diode Reverse Recovery Time

FGHL40T120RWD

TYPICAL CHARACTERISTICS

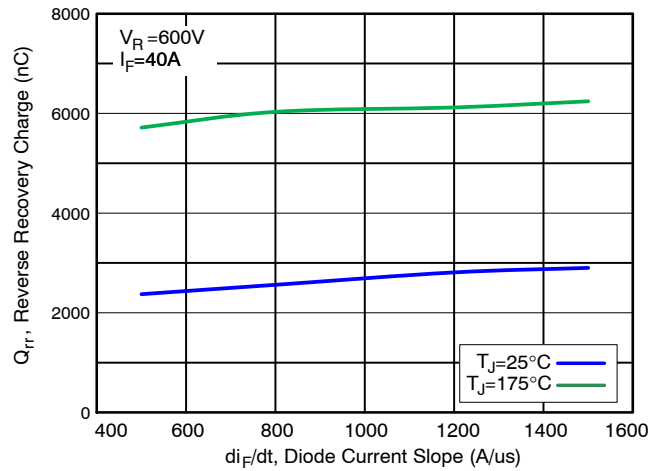

Figure 19. Diode Stored Charge Characteristics

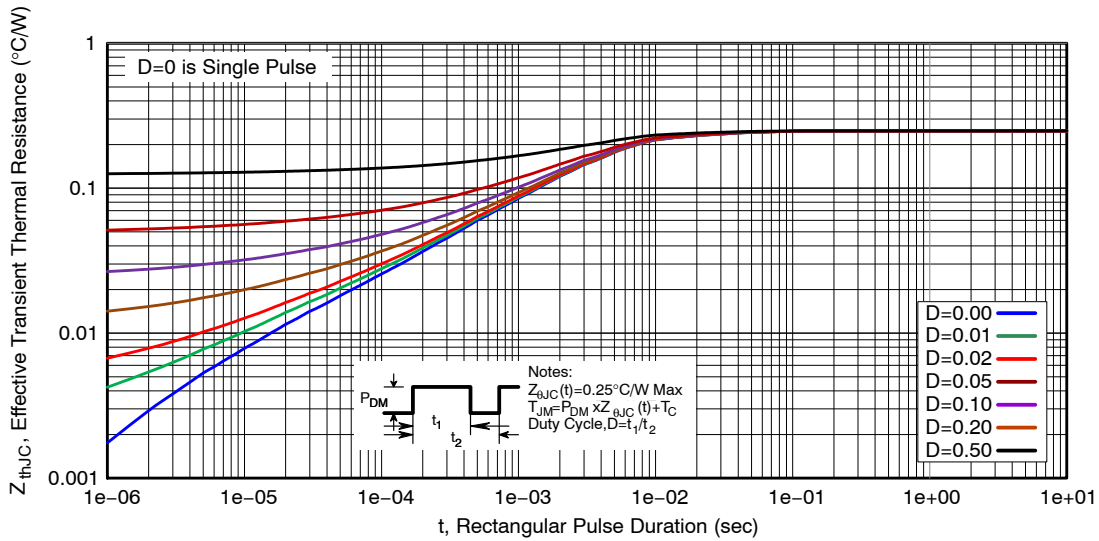

Figure 20. Transient Thermal Impedance of IGBT

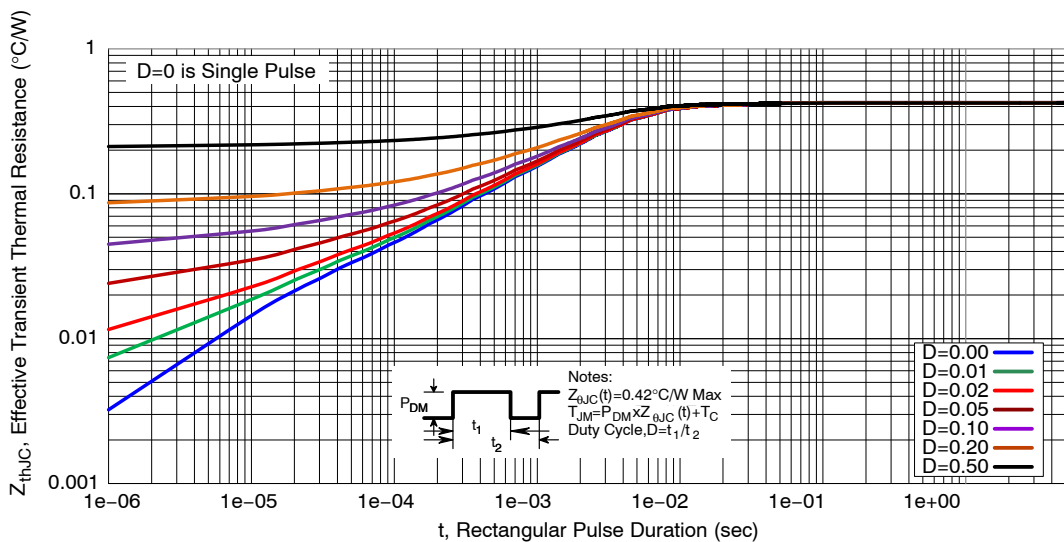

Figure 21. Transient Thermal Impedance of Diode

MECHANICAL CASE OUTLINE

PACKAGE DIMENSIONS

ON Semiconductor®



TO-247-3LD
CASE 340CX
ISSUE A

DATE 06 JUL 2020

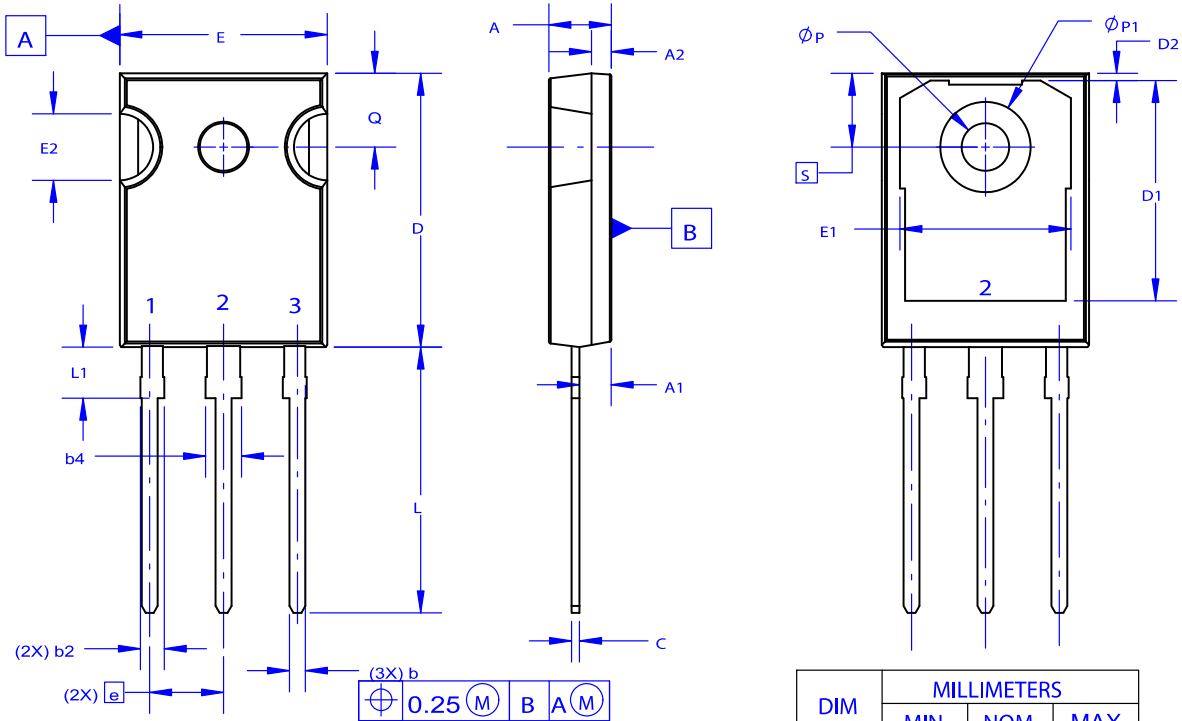
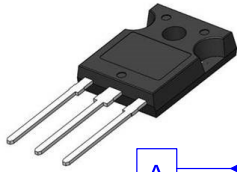

NOTES: UNLESS OTHERWISE SPECIFIED.

- A. DIMENSIONS ARE EXCLUSIVE OF BURRS, MOLD FLASH, AND TIE BAR EXTRUSIONS.
- B. ALL DIMENSIONS ARE IN MILLIMETERS.
- C. DRAWING CONFORMS TO ASME Y14.5 - 2009.
- D. DIMENSION A1 TO BE MEASURED IN THE REGION DEFINED BY L1.
- E. LEAD FINISH IS UNCONTROLLED IN THE REGION DEFINED BY L1.

DIM	MILLIMETERS		
	MIN	NOM	MAX
A	4.58	4.70	4.82
A1	2.20	2.40	2.60
A2	1.40	1.50	1.60
D	20.32	20.57	20.82
E	15.37	15.62	15.87
E2	4.96	5.08	5.20
e	~	5.56	~
L	19.75	20.00	20.25
L1	3.69	3.81	3.93
ØP	3.51	3.58	3.65
Q	5.34	5.46	5.58
S	5.34	5.46	5.58
b	1.17	1.26	1.35
b2	1.53	1.65	1.77
b4	2.42	2.54	2.66
c	0.51	0.61	0.71
D1	13.08	~	~
D2	0.51	0.93	1.35
E1	12.81	~	~
ØP1	6.60	6.80	7.00

GENERIC MARKING DIAGRAM*



- XXXXX = Specific Device Code
- A = Assembly Location
- Y = Year
- WW = Work Week
- G = Pb-Free Package

*This information is generic. Please refer to device data sheet for actual part marking. Pb-Free indicator, "G" or microdot "▪", may or may not be present. Some products may not follow the Generic Marking.

DOCUMENT NUMBER:	98AON93302G	Electronic versions are uncontrolled except when accessed directly from the Document Repository. Printed versions are uncontrolled except when stamped "CONTROLLED COPY" in red.
DESCRIPTION:	TO-247-3LD	PAGE 1 OF 1

ON Semiconductor and are trademarks of Semiconductor Components Industries, LLC dba ON Semiconductor or its subsidiaries in the United States and/or other countries. ON Semiconductor reserves the right to make changes without further notice to any products herein. ON Semiconductor makes no warranty, representation or guarantee regarding the suitability of its products for any particular purpose, nor does ON Semiconductor assume any liability arising out of the application or use of any product or circuit, and specifically disclaims any and all liability, including without limitation special, consequential or incidental damages. ON Semiconductor does not convey any license under its patent rights nor the rights of others.

onsemi, **Onsemi**, and other names, marks, and brands are registered and/or common law trademarks of Semiconductor Components Industries, LLC dba "**onsemi**" or its affiliates and/or subsidiaries in the United States and/or other countries. **onsemi** owns the rights to a number of patents, trademarks, copyrights, trade secrets, and other intellectual property. A listing of **onsemi**'s product/patent coverage may be accessed at www.onsemi.com/site/pdf/Patent-Marking.pdf. **onsemi** reserves the right to make changes at any time to any products or information herein, without notice. The information herein is provided "as-is" and **onsemi** makes no warranty, representation or guarantee regarding the accuracy of the information, product features, availability, functionality, or suitability of its products for any particular purpose, nor does **onsemi** assume any liability arising out of the application or use of any product or circuit, and specifically disclaims any and all liability, including without limitation special, consequential or incidental damages. Buyer is responsible for its products and applications using **onsemi** products, including compliance with all laws, regulations and safety requirements or standards, regardless of any support or applications information provided by **onsemi**. "Typical" parameters which may be provided in **onsemi** data sheets and/or specifications can and do vary in different applications and actual performance may vary over time. All operating parameters, including "Typicals" must be validated for each customer application by customer's technical experts. **onsemi** does not convey any license under any of its intellectual property rights nor the rights of others. **onsemi** products are not designed, intended, or authorized for use as a critical component in life support systems or any FDA Class 3 medical devices or medical devices with a same or similar classification in a foreign jurisdiction or any devices intended for implantation in the human body. Should Buyer purchase or use **onsemi** products for any such unintended or unauthorized application, Buyer shall indemnify and hold **onsemi** and its officers, employees, subsidiaries, affiliates, and distributors harmless against all claims, costs, damages, and expenses, and reasonable attorney fees arising out of, directly or indirectly, any claim of personal injury or death associated with such unintended or unauthorized use, even if such claim alleges that **onsemi** was negligent regarding the design or manufacture of the part. **onsemi** is an Equal Opportunity/Affirmative Action Employer. This literature is subject to all applicable copyright laws and is not for resale in any manner.

ADDITIONAL INFORMATION

TECHNICAL PUBLICATIONS:

Technical Library: www.onsemi.com/design/resources/technical-documentation
onsemi Website: www.onsemi.com

ONLINE SUPPORT: www.onsemi.com/support

For additional information, please contact your local Sales Representative at www.onsemi.com/support/sales